

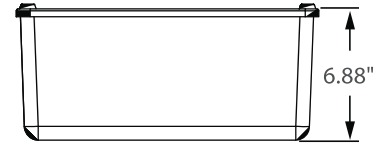

**** AVAILABLE ****

Bi-Level Dimming
100% 50%

0 - 10V
FULL DIMMING

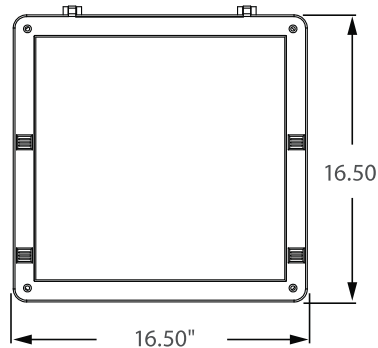

Incredible **75,000 hrs**

GENERAL DESCRIPTION

Neptun's 16" LED flood light fixture combines classic form and versatility to make it an excellent choice for new construction or retrofit applications. The LED-38 series flood fixture is offered in a variety of wattages and mounting options to provide maximum flexibility in all types of applications. It can replace existing HID & HPS fixtures up to 400W.

APPLICATION

- Parking Lot Lighting
- Car Lot Lighting
- Area & Storage Lighting
- Street Lighting
- Walkway Lighting
- Building Accent Lighting
- Sign / Monument Lighting

STRUCTURE, MATERIALS, & FEATURES

- Heavy-gauge, die-cast aluminum housing.
- Integral structural support plate for mounting arm ensures strength.
- Corrosion resistant electrocoat dark bronze finish (custom colors available).
- Hinged aluminum door frame incorporates stainless steel hardware.
- Continuous silicone gasketing surrounds optics for weather - tight seal.
- Correlated Color Temperature of (5000°K) for greater visibility and safety.
- High Output COB Cree LED's.
- Driver with built in Neptun Surge Protective Device (NSPD) provides single phase protection for Line/Neutral, Line/Ground, and Neutral/Ground in accordance with IEEE C62.41 C High (10kV & 10kA).
- InstantON flicker-free Cold Start and Hot Re-Start.
- Up to 15 years Maintenance free operation.
- 10 Year Warranty on complete fixture. (LED's, Driver, & Housing)
- **Optional:** 0-10V Dimming, Bi-Level Dimming, Wi-Fi Control, Remote Monitoring and ON/ OFF Control, DC 24V Operation - Solar Compatible

ORDERING INFORMATION

Sample Number: LED-38100-UNV-BL-DIM-SF-850-LD-T3-BRZ
Custom options and accessories available. Please consult factory.

Series	Wattage	Voltage	Options	Mounting	CCT	Accessories	Optics	Color
LED-38 = Flood Area/Parking Fixture	080 = 80 W 100 = 100 W 120 = 120 W 150 = 150 W	UNV = 120-277 VAC 347V = 347 VAC 480V = 480 VAC 24VDC = 24 VDC	0-10VDIM = 0-10V Dimming BL-DIM = Bi-Level Dimming * * Includes Motion Sensor	SF = Slip-Fitter Mount YK = Yoke Bracket Mount * See Pg. 2 for mounting options	835 = 3500°K 841 = 4100°K 850 = 5000°K * * Standard	LD = Twistlock Photocell MD = Motion Sensor ON/OFF FSGS = Front Side Glare Shield LGN = Light Genie Node ** ** Contact factory for product information	T3 = Type 3 T5 = Type 5	BRZ = Bronze * Custom Colors Available



lightinnovations@work™



Southern Electronics (Bangalore) Pvt. Ltd.

16-A, Phase 1, Peenya Industrial Area, Bangalore - 560 058, India

Ph: +91 80 39280341/42/45/46/49 Fax: +91 80 39280365

Website: www.seonics.co.in Email: southern@vsnl.com

PRODUCT INFORMATION

Model No.	Description	Rated Watts	Input Watts	Initial Lumens	Universal Line Voltage (VAC)	Max Line Current (Amp) @ 120 - 277	THD	Power Factor	Weight
LED-38080-UNV	LED Flood Light Fixture	80	82	8,200	120-277	0.69 - 0.30	<20%	>0.90	25 lbs
LED-38100-UNV	LED Flood Light Fixture	100	102	9,486	120-277	0.87 - 0.37	<20%	>0.90	25 lbs
LED-38120-UNV	LED Flood Light Fixture	120	122	11,590	120-277	1.05 - 0.45	<20%	>0.90	25 lbs
LED-38150-UNV	LED Flood Light Fixture	150	152	13,770	120-277	1.31 - 0.56	<20%	>0.90	25 lbs

SPECIFICATIONS

- Driver Constant Current
- Start Method InstantON
- Hot Re-start InstantON
- Power Supply 350mA
- Driver UL Rating Class 1
- Driver UL Outdoor Rated Wet Location
- Sound Rating Class A
- ANSI Surge Protection IEEE C62.41 C High
- Current Crest Factor 1.5 maximum
- Load Regulation: 5% output current variation across load range
- Line Regulation: 1% output voltage variation across voltage range
- Driver Off-State Draw 0 Watts
- Vibration Compliance 3G
- Universal Input Line Voltage 120-277 VAC
- Input Line Frequency 50/60 Hz
- LED / Driver System Life 75,000 Hrs.
- Lumen Maintenance @50,000Hrs > 70%
- Color Temperature 5,000°K
- Color Rendering Index (CRI) > 80
- Minimum Starting Temperature -40°C
- Maximum Starting Temperature +50°C
- Lumens per Watt > 90
- Shock / Vibration Resistant Yes
- Power Factor > 0.90
- Total Harmonic Distortion < 20%
- Inrush Current Peak < 10 Amp
- FCC Compliance Part 15, Subp. C
- ETL Listed / UL Standard 1598 Yes
- EPA Rating 0.96 ft.²
- Driver IP Rating IP67
- Optics IP Rating IP68
- Warranty 10 Year

MOUNTING OPTIONS

Slip Fitter (SF)

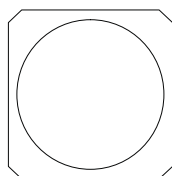
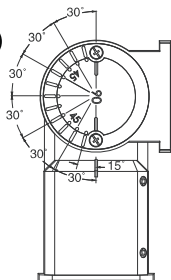

2-1/2" I.D.
Accepts up to 2-3/8"
Tenon or Pipe

Yoke Bracket (YK)

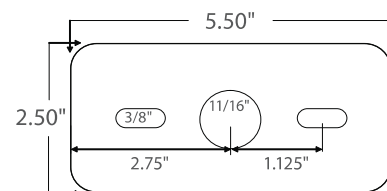
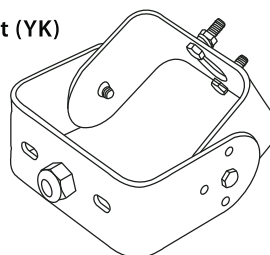

PHOTOMETRICS (See Complete IES File)

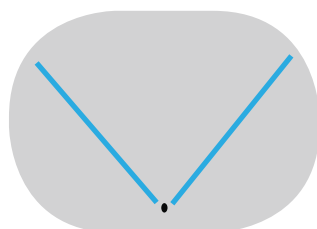

Type 3 Distribution

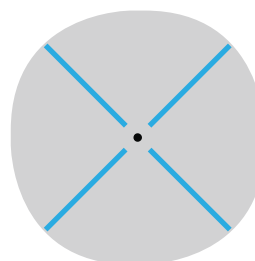

Type 5 Distribution



Southern Electronics (Bangalore) Pvt. Ltd.

16-A, Phase 1, Peenya Industrial Area, Bangalore - 560 058, India

Ph: +91 80 39280341/42/45/46/49 Fax: +91 80 39280365

Website: www.seonics.co.in Email:southern@vsnl.com